

User manual | ERC 21X temperature controllers series

ERC 21X, smart multipurpose refrigeration controller

4

push buttons, a big display and an intuitive menu structure ensure superior ease of use.



Table of contents

1 	Introduction	4
1.1	Application	4
1.2	General Description	4
1.3	ERC 21X Series	5
1.3.1	ERC 211	5
1.3.2	ERC 213	5
1.3.3	ERC 214	5
2 	Key features	6
2.1	Voltage protection	6
2.2	Compressor protection	6
2.3	Compressor protection against high condensing temperature	6
2.4	Pre-defined applications	7
2.5	Fan pulsating during compressor OFF cycle	9
2.6	Defrost on Demand	10
3 	Technical Specification	10
4 	Installations	11
4.1	Dimensions (mm)	11
4.2	Mounting	11
4.3	Installation steps	11
4.4	Electrical connection diagram	12
4.4.1	ERC 211 - connection diagram	12
4.4.2	ERC 213 - connection diagram	12
4.4.3	ERC 214 - connection diagram	12
4.5	Power supply	13
4.6	Sensors	13
4.7	Electric noise	13
5 	Menu Navigation and overview	13
5.1	Key functions and display Icons	13
5.2	Quick Configuration at power up	13
5.3	Menu Structure	14
5.4	Quick Configuration via "cFg" menu	15
5.5	Adjust set point temperature	15
5.6	Initiate a manual defrost	15
5.7	Initiate a pull down	15
5.8	View active alarm	15
5.9	Unlock keyboard	15
6 	Menu functions	16
7 	Parameter table	22
7.1	Parameter table - ERC 211	22
7.2	Parameter table - ERC 213	25
7.3	Parameter table - ERC 214	29
7.4	Alarm Code	33
7.5	Troubleshooting	33
8 	Ordering	33
8.1	Sensors	34

1| Introduction

1.1| Application

ERC 21X is a smart multipurpose refrigeration controller designed to fulfill today's requirement of commercial refrigeration applications. This controller is suitable for high, medium and low temperature applications with natural, electrical and hot gas defrost compatibilities. Typical applications include Glass door merchandisers, commercial fridges and freezers, cold rooms and various other commercial refrigeration applications.

1.2| General Description

ERC21X controller comes with four push buttons, a big display, easy and intuitive menu structure and pre-defined applications ensure ease of use. Controller is loaded with energy efficiency features like smart evaporator fan management, day/night mode and defrosts on demand features.

High Effect 16 A relay enable direct connection of heavy loads without use of intermediate relay: up to 2 hp compressors depending on its power factor and motor efficiency (greater than 0.65 for 230 V and greater than 0.85 for 115 V).

Safe operation of the unit is ensured through voltage protection and high condensation temperature protection features.



1.3| ERC 21X Series

Three version of ERC 21X is available in both 230 V / 50/60 Hz and 115 V / 60 Hz.

- **ERC 211:** single relay output for refrigeration and heating applications.
- **ERC 213:** three relays outputs for ventilated refrigeration applications.
- **ERC 214:** four relays outputs for ventilated refrigeration applications.

1.3.1| ERC 211

ERC 211 has one relay output and two inputs (1 analogue, 1 analogue/digital).

This controller can be used for either cooling or heating applications.

Outputs:

- Relay 1: compressor/solenoid valve control or simple heater in case of heating application

Inputs:

- Input 1: cabinet/control sensor (Sair).
- Input 2: condenser sensor or digital inputs which can be configured for various functions as mentioned under menu code o02.

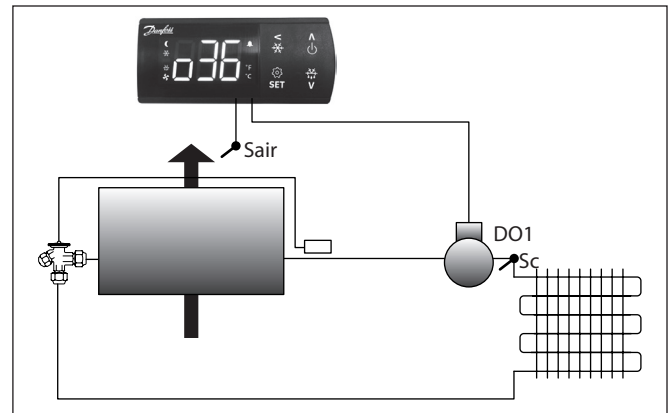

1.3.2| ERC 213

ERC 213 has three relays outputs and four inputs (2 analogues, 1 analogue/digital, 1 digital) for cooling applications.

Outputs:

- Relay 1: compressor/solenoid valve control.
- Relay 2: can be configured either defrost or external alarm.
- Relay 3: fan control.

Inputs:

- Input 1: cabinet/control sensor (Sair).
- Input 2: defrost sensor (S5).
- Input 3 : condenser sensor (Sc) or digital input which can be configured to various functions as mentioned under menu code "o02".
- Input 4: digital input which can be configured to various functions as mentioned under menu code "o37"

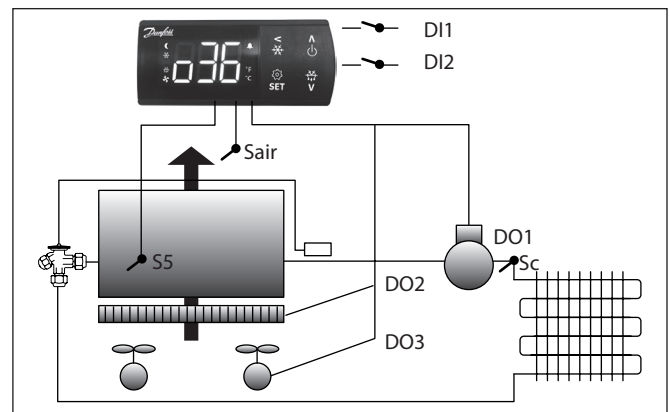

1.3.3| ERC 214

ERC 214 has four relays outputs and four inputs (2 analogue, 1 analogue/digital, 1 digital) for cooling applications.

Outputs:

- Relay 1: compressor/solenoid valve control.
- Relay 2: defrost control.
- Relay 3: fan control.
- Relay 4 : this can be configured for either light or external alarm.

Inputs:

- Input 1: cabinet/control sensor (Sair).
- Input 2: defrost sensor (S5).
- Input 3 : condenser sensor (Sc) or digital input which can be configured to various functions as mentioned under menu code "o02".
- Input 4: digital input which can be configured to various functions as mentioned under menu code "o37".

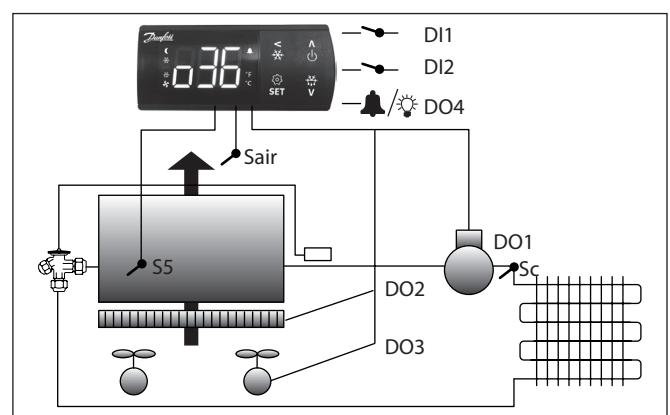

2| Key features

2.1| Voltage protection

Protection against high and low voltage by limiting the compressor operation within specified voltage limits. Whenever the supply voltage goes beyond the defined voltage protection limits controller will shut the compressor OFF and flashes alarm on the display. It will restore the operation when the voltage falls under the operating range respecting minimum stop time.

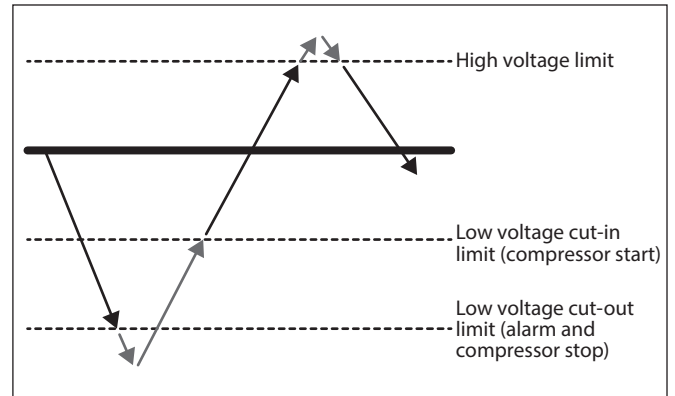

2.2| Compressor protection

Parameters for Minimum ON and OFF time, protect the compressor by short cycling/sudden switching ON and OFF by defining minimum ON and OFF time.

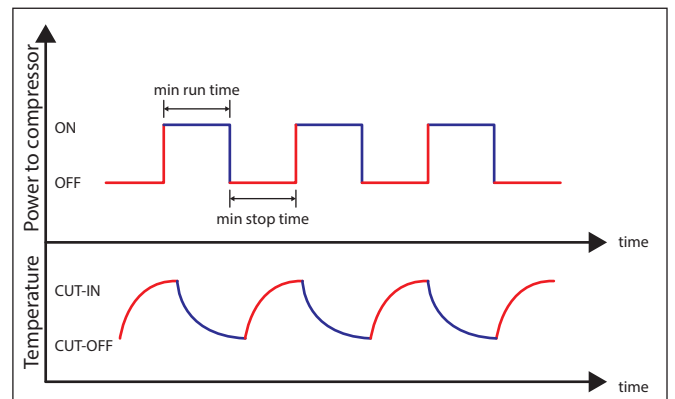

2.3| Compressor protection against high condensing temperature

If the condenser is blocking up with dirt and thereby reaches a too high condensing temperature, controller will give the user early warning through condenser alarm and if temperature rises further it will switch the compressor OFF. If the temperature measured by the condenser sensor (Sc) is reaching the set "pre alarm limit" a alarm is raised, but no further action is taken.

This is used to indicate to the user that something is wrong with the condenser. Often the reason is that the air flow to the condenser is restricted (dirt) or because the condenser fan is broken.

The alarm will reset if the condenser temperature drops back by 5 °C. If the measured condenser temperature continues to increase and reaches the set "Block limit" the compressor is stopped and it is restricted from starting again until the alarm is reset manually.

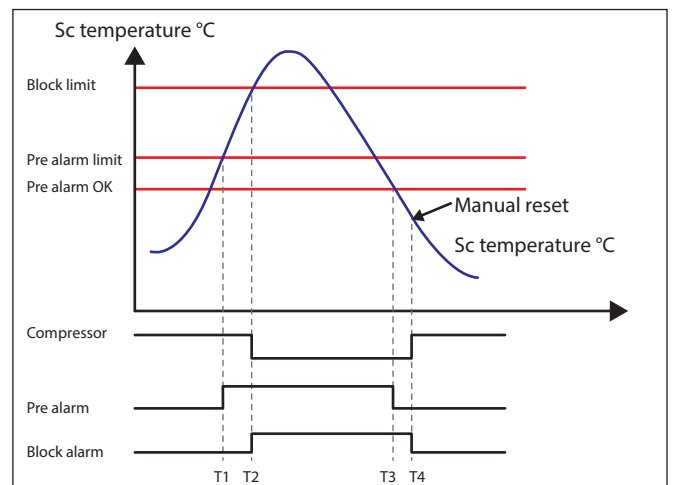

2.4| Pre-defined applications

The purpose of the Predefined applications is to give the user an easy and fast way to configure the controller to a specific application based on **storage temperature** (LT, MT, HT), **defrost type** (none, natural, electrical) and **defrost method** (terminated on time or temperature).

When user select specific application based on their requirements, the controller will load a specific set of parameter values and will hide parameters that are not relevant for the selected application.

Adjustment of the set of parameters value will be still possible at any time.

In addition to pre-defined applications, all controller versions have two standard applications, one with full list of parameters and another with simplified list of parameters, that allows the user to make their own customized parameter settings (AP0 and AP5 in case of ERC211 and AP0 and AP6 in case of ERC213 / ERC214).

Pre-defined application table of ERC 211 controller

App	Mode	Description	Temperature	Defrost type	Defrost end
App 0	Cooling/ Heating	No predefined application			
App 1	Cooling	Medium temperature without defrost	(4 – 20 °C)	None	None
App 2	Cooling	Medium temperature with timed natural defrost	(2 – 6 °C)	Natural	Time
App 3	Cooling	Medium temperature with natural defrost stop on air temperature	(2 – 6 °C)	Natural	Air temperature
App 4	Heating	Heating Thermostat	(20 – 60 °C)	None	None
App 5	Cooling/ Heating	No predefined application with simplified list of parameter			

Selection 1 covers applications where a standard cooling thermostat is needed and no defrosts are performed.

Selection 2 covers normal temperature applications with natural defrost with stop on time.

Selection 3 covers normal temperature applications with natural defrost with stop on air temperature.

Selection 4 covers applications where a simple heating thermostat is needed (no defrost).

Selection 5 covers applications where a reduced parameter list is recommended.

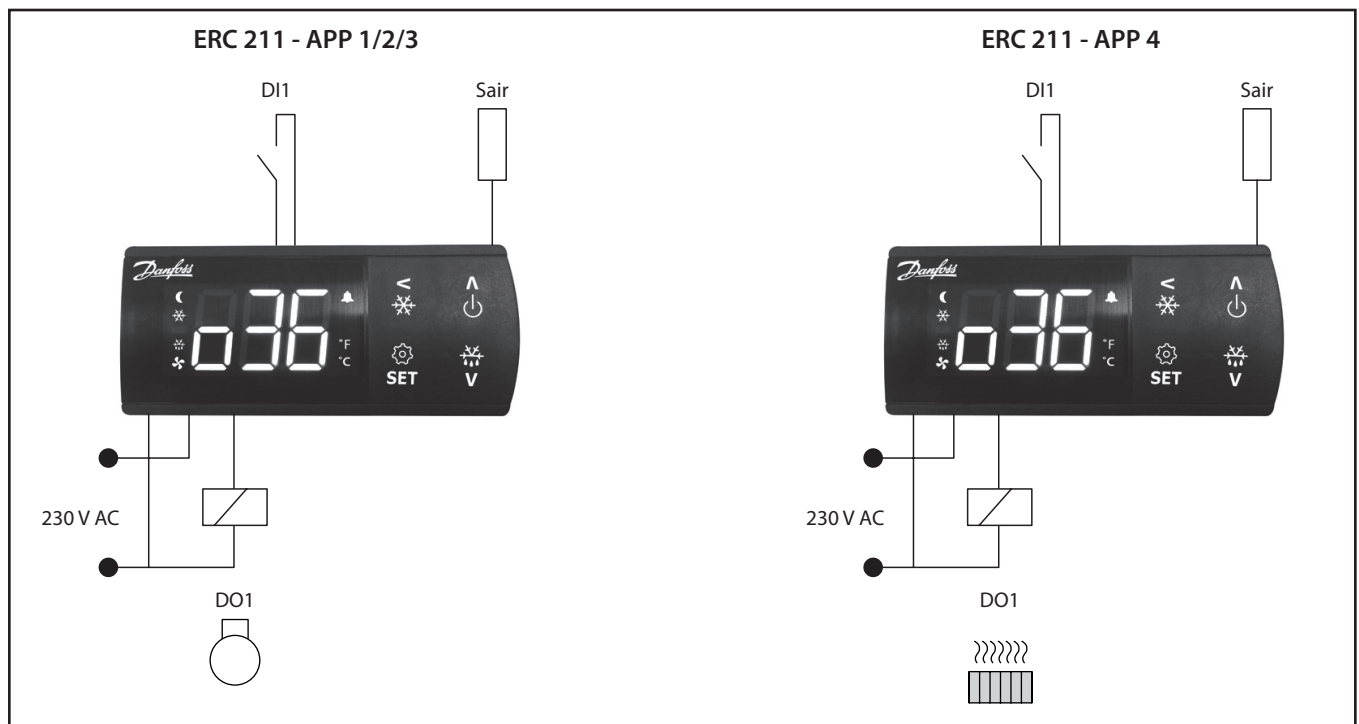

Pre-defined application table of ERC 213 controller

App	Mode	Description	Temperature	Defrost type	Defrost end
App 0	Cooling	No predefined application			
App 1	Cooling	Medium temperature ventilated refrigeration units with timed natural defrost	(2 – 6 °C)	Natural	Time
App 2	Cooling	Medium temperature ventilated refrigeration units with timed electrical defrost	(0 – 4 °C)	Electrical	Time
App 3	Cooling	Low temperature ventilated refrigeration units with timed electrical defrost	(-26 – -20 °C)	Electrical	Time
App 4	Cooling	Medium temperature ventilated refrigeration units with electrical defrost (by temperature)	(0 – 4 °C)	Electrical	Temperature
App 5	Cooling	Low temperature ventilated refrigeration units with electrical defrost (by temperature)	(-26 – -20 °C)	Electrical	Temperature
App 6	Cooling	No predefined application with simplified list of parameters			

Selection 1 covers normal temperature applications with natural defrost with stop on time.

Selection 2 and 3 covers respectively medium and low temperature applications with electrical defrost with stop on time.

Selection 4 and 5 covers respectively medium and low temperature applications with electrical defrost with stop on defrost sensor "S5".

Selection 6 covers applications where a reduced parameter list is recommended.

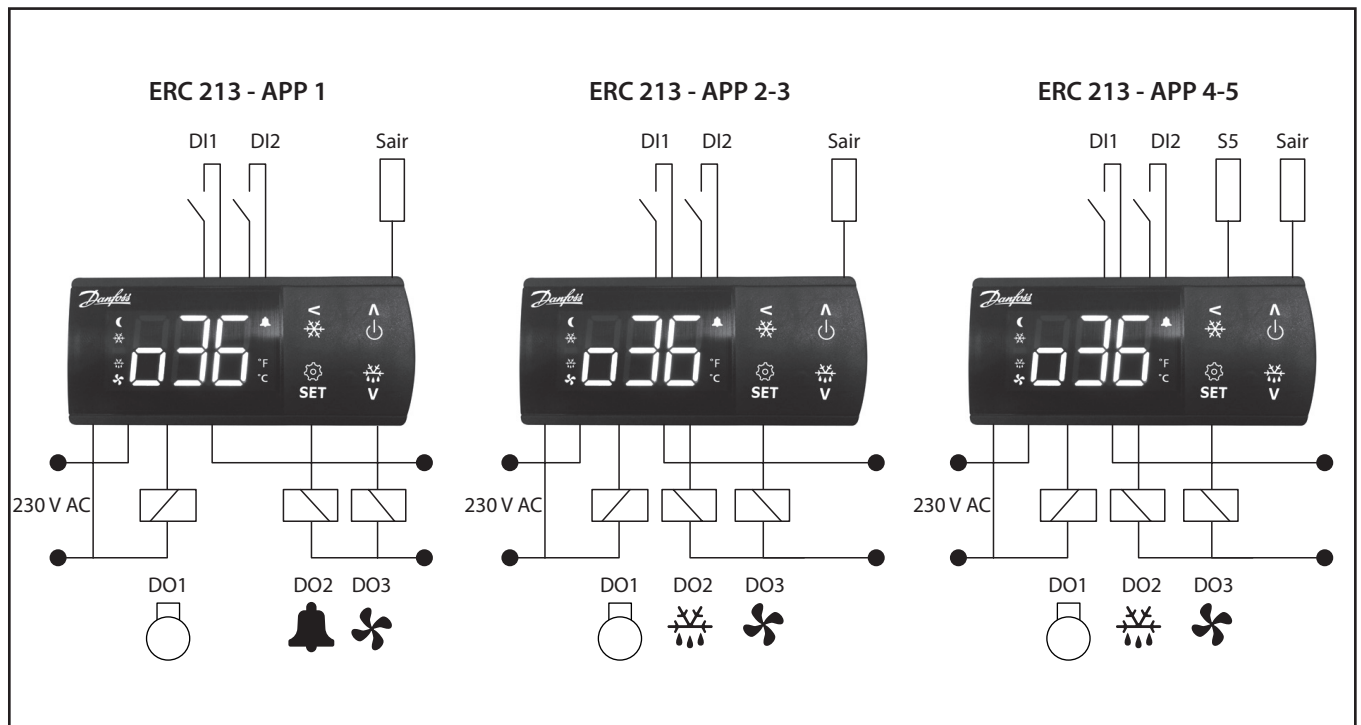

Predefined application table for ERC 214

App	Mode	Description	Temperature	Defrost type	Defrost end
App 0	Cooling	No predefined application			
App 1	Cooling	Medium temperature ventilated refrigeration units with timed natural defrost	(2 – 6 °C)	Natural	Time
App 2	Cooling	Medium temperature ventilated refrigeration units with timed electrical defrost	(0 – 4 °C)	Electrical	Time
App 3	Cooling	Low temperature ventilated refrigeration units with timed electrical defrost	(-26 – -20 °C)	Electrical	Time
App 4	Cooling	Medium temperature ventilated refrigeration units with electrical defrost (by temperature)	(0 – 4 °C)	Electrical	Temperature
App 5	Cooling	Low temperature ventilated refrigeration units with electrical defrost (by temperature)	(-26 – -20 °C)	Electrical	Temperature
App 6	Cooling	No predefined application with simplified list of parameters			

Selection 1 covers normal temperature applications with natural defrost with stop on time.

Selection 2 and 3 covers respectively medium and low temperature applications with electrical defrost with stop on time.

Selection 4 and 5 covers respectively medium and low temperature applications with electrical defrost with stop on defrost sensor "S5".

Selection 6 covers applications where a reduced parameter list is recommended.

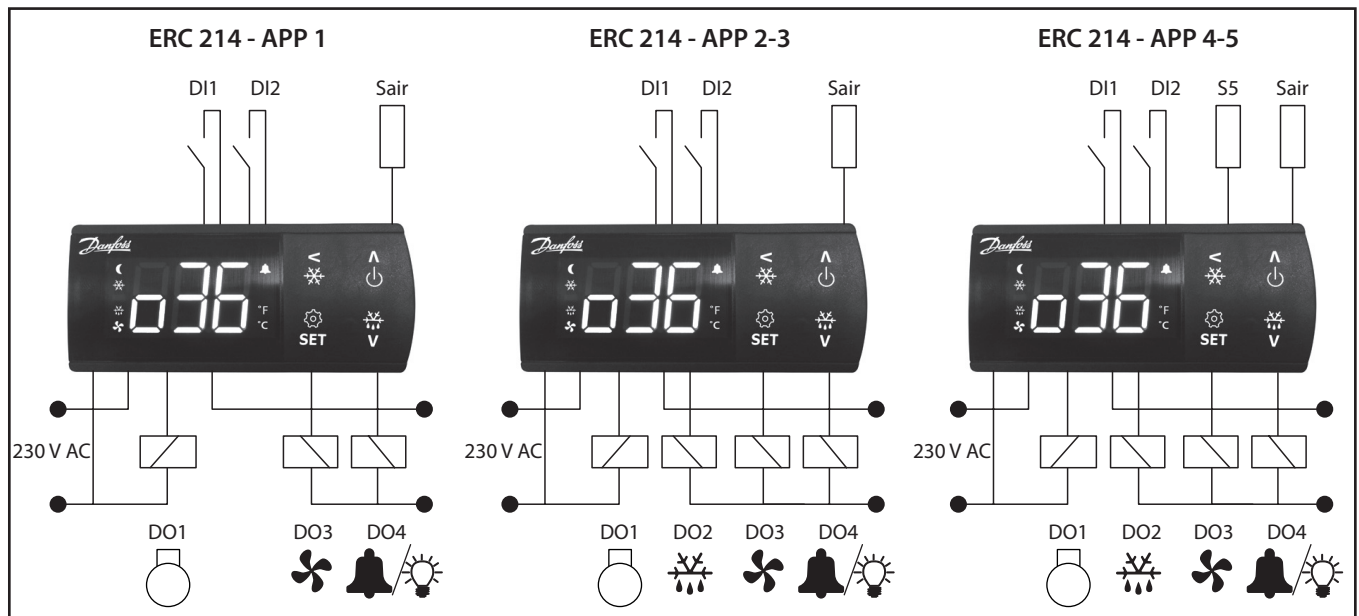

2.5| Fan pulsating during compressor OFF cycle

This is an energy saving feature. During compressor OFF cycle controller will run the fan with defined duty cycle to maintain uniform temperature and delay the need of compressor switching ON

2.6| Defrost on Demand

This feature records and averages the evaporator temperature recorded during the first three cut out of compressor immediately after defrost. The controller will constantly follow the evaporator temperature and compare with the above recorded average temperature. In between two defrosts, if the evaporator temperature goes below the previously recorded average temperature by "defrost on demand" value "d30", defrost will be triggered.

- This function can only be used in 1:1 systems.
- This function is disabled when the parameter "defrost on demand" is set to 20.
- Defrost on demand is triggered only if the time since the last defrost session has ended is greater than ¼ of the defrost interval or 2 hours whichever is lesser.
- Defrost doesn't start by this method during the following scenarios.
 - Pull down mode.
 - Night mode.
 - Main switch in DI or main switch in Menu is in OFF position.
 - Manual control mode.
 - Evaporator sensor senses a temperature which is greater than 0 °C.

3| Technical Specification

FEATURES	DESCRIPTION
Power supply	115 V AC / 230 V AC 50/60 Hz, galvanic isolated low voltage regulated power supply
Rated power	Less than 0.7 W
Inputs	4 inputs: 2 analogue, 1 analogue/digital and 1 digital
Allowed sensor types	NTC 5000 Ohm at 25 °C, (Beta value=3980 at 25/100 °C - e.g. EKS 211) NTC 10000 Ohm at 25 °C, (Beta value=3435 at 25/85 °C - e.g. EKS 221) PTC 990 Ohm at 25 °C, (e.g. EKS 111) Pt1000, (e.g. AKS 11, AKS 12, AKS 21)
Sensors included in Kit Solution	NTC 10000 Ohm at 25 °C, cable length: 1.5 m
Accuracy	Measuring range: -40 – 105 °C (-40 – 221 °F) Controller accuracy: ±1 K below -35 °C, ±0.5 K between -35 – 25 °C, ±1 K above 25 °C
Output	DO1 Compressor relay: 16 A, 16 (16) A, EN 60730 10 FLA / 60 LRA at 230 V, UL60730 16 FLA / 72 LRA at 115 V, UL60730 DO2 Defrost relay: 8 A, 2 FLA / 12 LRA, UL60730 8 A, 2 (2 A), EN60730 DO3 Fan relay: 3 A, 2 FLA / 12 LRA, UL60730 3 A, 2 (2 A), EN60730 DO4 Alarm/Light relay: 2 A
Display	LED display, 3 digits, decimal point and multi-function icons, °C + °F scale
Operating conditions	-10 – 55 °C (14 – 131 °F), 90% Rh
Storage conditions	-40 – 70 °C (-40 – 158 °F), 90% Rh
Protection	Front : IP65 (Gasket integrated) Rear: IP00
Environmental	Pollution degree II, non-condensing
Resistance to heat and fire	Category D (UL94-V0)
EMC category	Category I
Approvals	UL recognition (US & Canada) (UL 60730) ENEC (EN 60730) CQC CE (LVD & EMC Directive) EAC (GHOST) NSF ROHS2.0 HACCP temperature monitoring in compliance with EN134785 Class I, when used with AKS 12 sensor

4| Installations

4.1| Dimensions (mm)

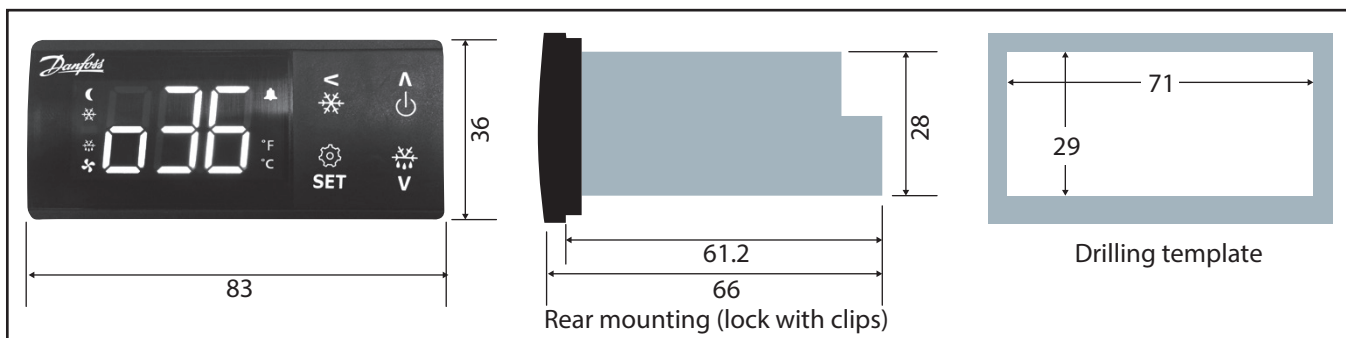

4.2| Mounting

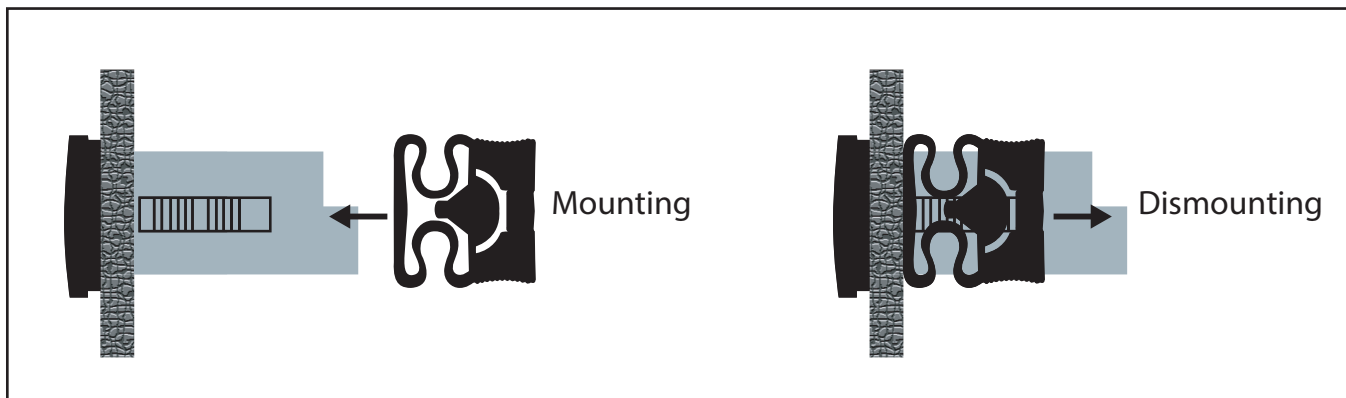

4.3| Installation steps

- Place the wired controller in the slot and ensure rubber sealing is resting properly on the mounting surface.
- Slide the mounting clips along the rails of the rear plastic from the rear side of the panel.
- Slide the clips towards mounting surface until controller is firmly fixed.
- To remove the controller, one needs to skillfully unlatch the snapping tab and pull the clips backwards.

4.4| Electrical connection diagram

4.4.1| ERC 211 - connection diagram

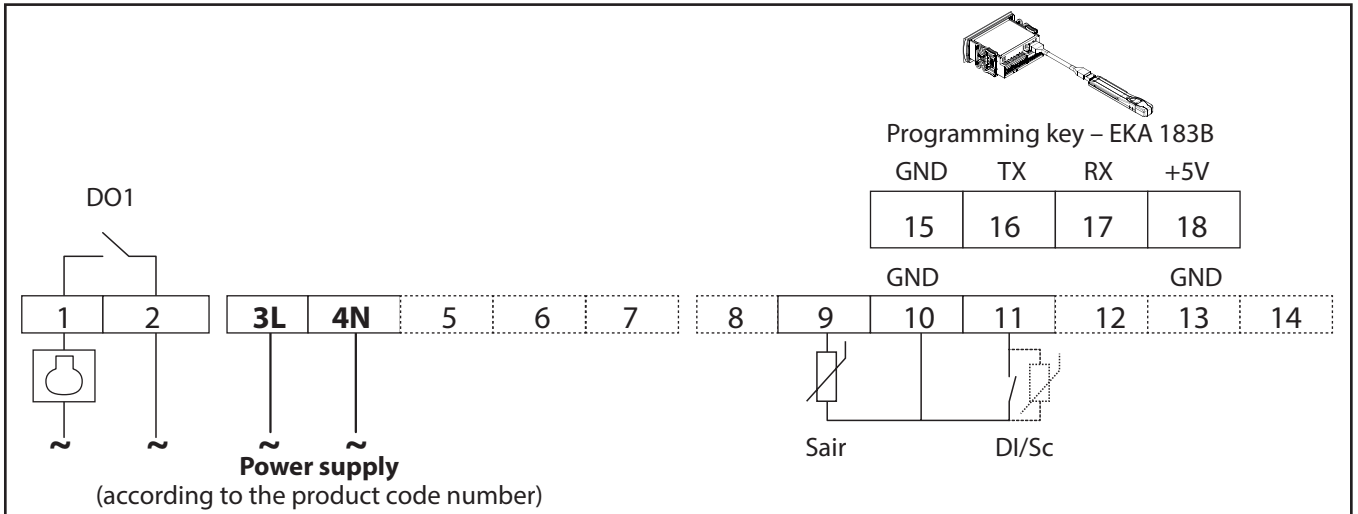

4.4.2| ERC 213 - connection diagram

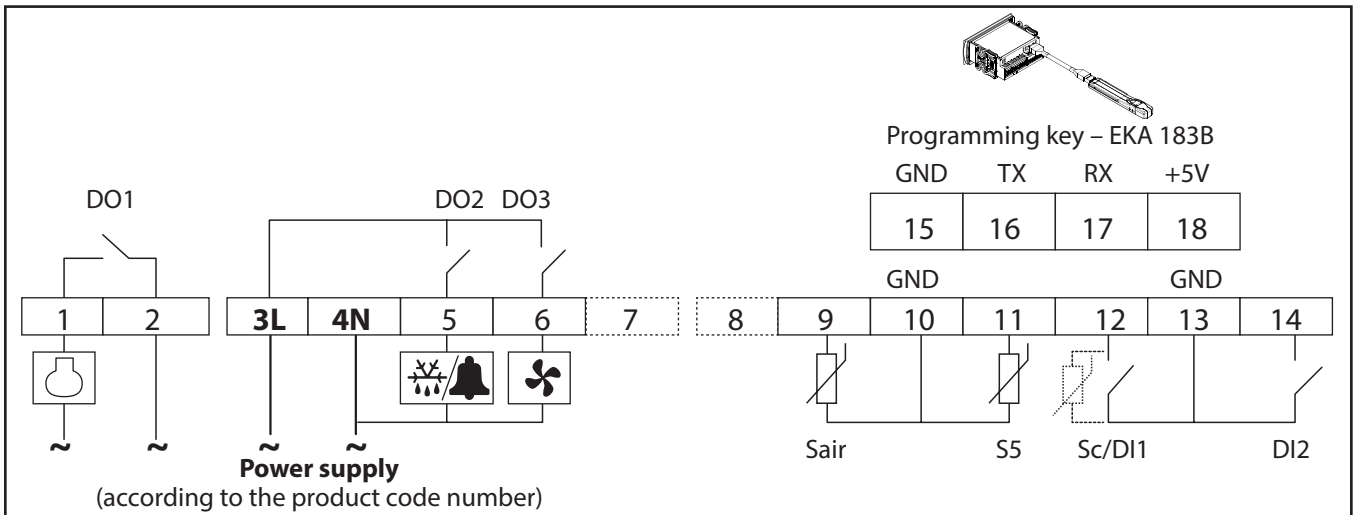

4.4.3| ERC 214 - connection diagram

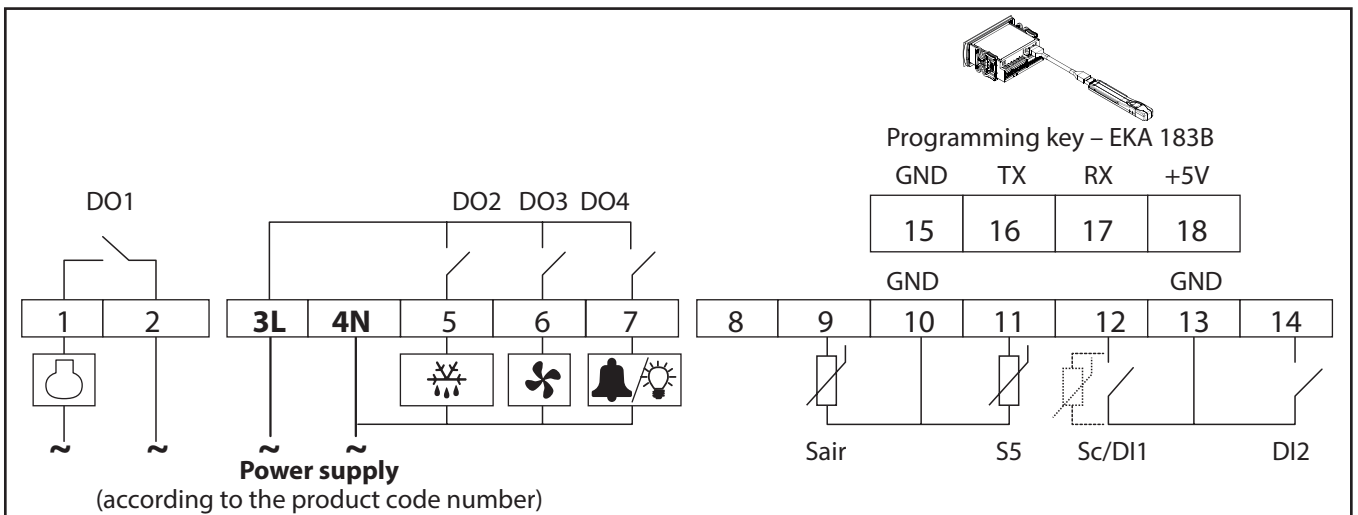

4.5| Power supply

115 V AC / 230 V AC / 50/60 Hz (Refer to the controller label).

4.6| Sensors

- **Sair** Control sensor.
- **S5** Defrost (evaporator) sensor.
- **Sc** Condenser sensor.
- **Di1** Digital input - configurable to the functions listed under menu code o02.
- **Di2** Digital input - configurable to the functions listed under menu code o37.













4.7| Electric noise

Cables for sensors and DI inputs must be kept separate from other electric cables:

- Use separate cable trays.
- Keep a distance between cables of at least 10 cm.
- Long cables at the DI input should be avoided.

5| Menu Navigation and overview

5.1| Key functions and display icons

Key Function	
	Press for one second: UP Press and hold: ON/OFF
	Press and hold at power up: FACTORY RESET ("FAC" is displayed)
	Press for one second: DOWN Press and hold: DEFROST
	Press for one second: BACK
	Press and hold: PULL-DOWN
	Press for one second: TEMPERATURE SETPOINT/OK
SET	Press and hold: MENU
Display Icons	
	Night mode (Energy saving)
	Fan running
	Compressor running (Flashes in pull-down mode)
	Active alarm
	Defrost
	Unit (°C or °F)

5.2| Quick Configuration at power up

- **STEP 1: power on**
- **STEP 2: select the quick configuration menu**
Within 30 seconds of power on, press "<" BACK for 3 seconds. The main switch "r12" is automatically set to OFF.
- **STEP 3: select pre-installed application "o61"**
The display automatically shows the application selection parameter "o61".
Press SET to select the pre-installed application.
The display shows the default value (eg. "AP0" flashing).
Choose the application type by pressing UP/DOWN and press SET to confirm.
The controller presets parameter values according to the selected application and does not hide relevant parameters.
Tip: you can easily move from AP0 to AP6, and thus select the simplified list of parameters, by pressing the UP key (circular list).

App	Description (e.g. for ERC213 and ERC214)
App 0	None (no preset application)
App 1	Medium temperature (2 – 6 °C), ventilated ref. units with timed natural defrost
App 2	Medium temperature (0 – 4 °C), ventilated ref. units with timed electrical defrost
App 3	Low temperature (-26 – -20 °C), ventilated ref. units with timed electrical defrost
App 4	Medium temperature (0 – 4 °C), ventilated ref. units with electrical defrost (by temperature)
App 5	Low temperature (-26 – -20 °C), ventilated ref. units with electrical defrost (by temperature)
App 6	None (no preset application) with simplified parameter list

Note: refer to chapter 2.4 - "Pre-defined Applications" for a complete description of the available applications.

– STEP 4: select sensor type “o06”

The display automatically shows sensor selection parameter “o06”.

Press SET to select the sensor type.

The display shows the default value (eg. “n10” flashing).

Choose sensor type by pressing UP/DOWN (n5=NTC 5 K, n10=NTC 10 K, Ptc=PTC, Pt1=Pt1000) and press SET to confirm.

NOTE: all sensors must be the same type.

– STEP 5: configure DO4 output “o36”

The display automatically shows the “o36” parameter to configure “DO4” output. (Available only in 4 relays model).

Select light “Lig” or alarm “ALA” as per the application and press SET to confirm.

The display returns to normal display mode and the control is started.

5.3| Menu Structure

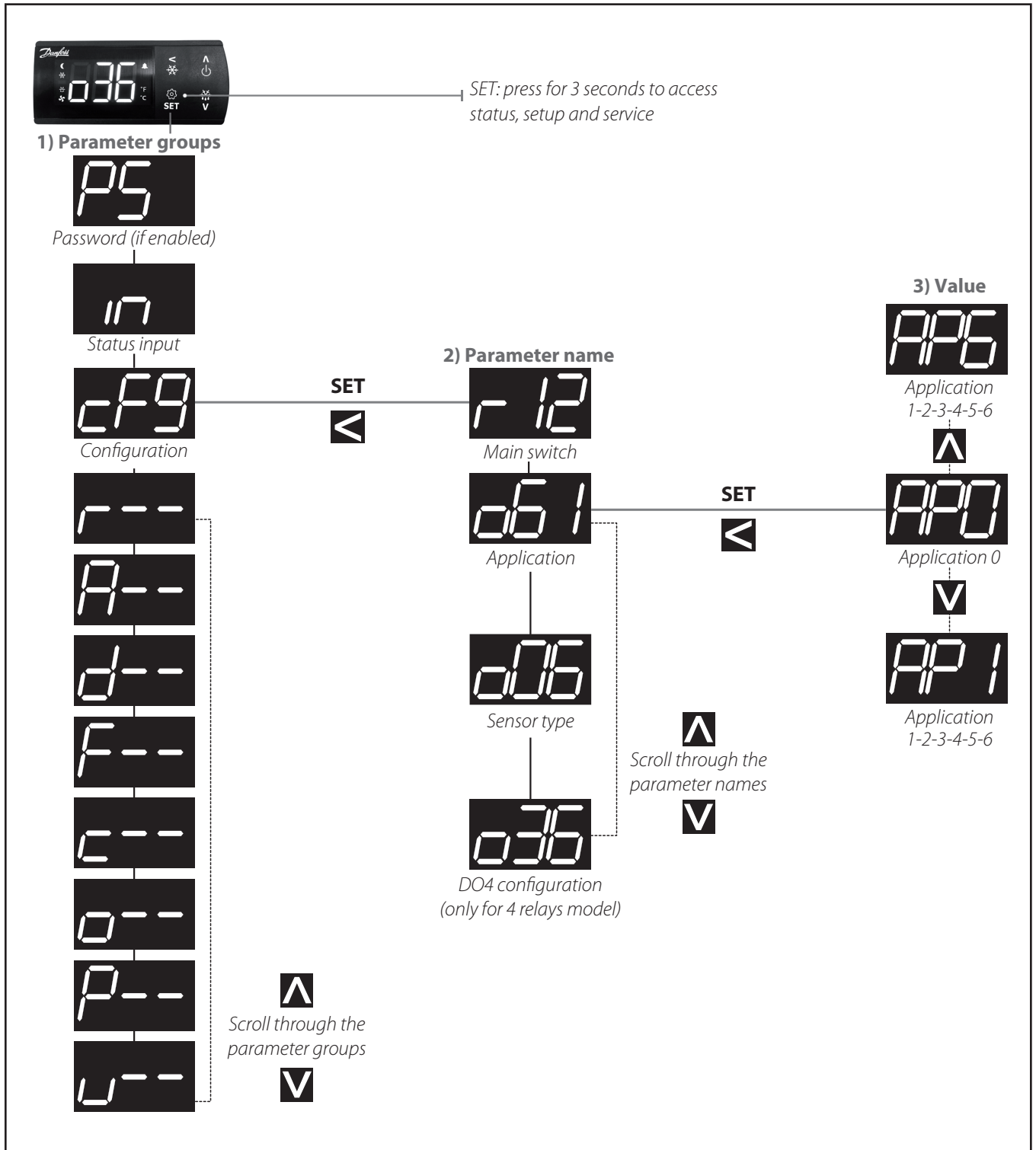

5.4| Quick Configuration via "cFg" menu

- Press SET for three seconds to access the parameters groups.
- Select "cFg" menu and press SET to enter. The first menu "r12" (main switch) is displayed.
- Switch OFF main switch (r12=0) for changing the pre-installed application.
- Press UP/DOWN to scroll through the parameter list.
- Configure the "o61" parameter to select a pre-installed application:
 - Press SET to access the "o61" parameter.
 - Press UP/DOWN to select an application.
 - Press SET to confirm, "o61" is displayed.
- Continue to set the next parameters ("o06" sensor type and "o36" DO4 configuration) in the "cFg" menu.

5.5| Adjust set point temperature



(short press) SET: adjust setpoint temperature.

UP/DOWN: change the temperature setpoint (in setting mode the setpoint flashes).

SET: save the temperature setpoint.

5.6| Initiate a manual defrost



DEFROST: press for 3 seconds to initiate a defrost.

DEFROST: press for 3 seconds to stop manual defrost. The DEFROST icon is shown during defrost.

5.7| Initiate a pull down



PULL DOWN: press for 3 seconds to initiate pull down.

"Pud": is shown for 3 seconds to indicate pull down. The PULL DOWN icon flashes during pull down.

PULL DOWN: press for 3 seconds to stop pull down.

5.8| View active alarm



Temperature and alarm codes alternate flashes until the alarm is resolved. The alarm bell is shown.

5.9| Unlock keyboard



- After 5 minutes of no activity, the keypad is locked (if P76=yes).
- When the keypad is locked any button press shows "LoC" in the display.
- Press UP and DOWN buttons simultaneously for 3 seconds to unlock the keyboard. "unl" is displayed for 3 seconds.

6| Menu functions

Menu code	Parameter description
cFg	Configuration
r12	Main switch With this setting refrigeration can be started, stopped or a manual override of the outputs can be allowed. Stopped refrigeration will give a "OFF" signal on the display. <i>-1=service (manual control of outputs allowed)</i> <i>0=OFF</i> <i>1=ON</i>
o61	Predefined applications Predefined applications is to give the user an easy and fast way to configure the controller refer to a specific application based on storage temperature, defrost type and defrost method. Users can set appropriate application that meets their requirements under this menu (please refer predefined applications table under section 2.4 for more details). Predefined application is protected by main switch.
o06	Sensor type selection This parameter is for defining type of temperature sensors connected to the controller. User can configure NTC 5 K, NTC 10 K, PTC and PT1000 sensors in this controller. All the mounted sensors (Sair, S5 and Sc) must be of same type.
o36	DO4 configuration This parameter is to configure 4 th relay as light or Alarm in case of four relay controller (ERC214). <i>Lig=light</i> <i>ALA=alarm</i>
r--	Reference
r00	Temperature setpoint This parameter defines the desired cabinet temperature at which compressor cuts out. The set value can be locked or limited to a range with the settings in "r02" and "r03".
r01	Differential This defines the difference between the cut-out and the cut-in of compressor relay. Compressor relay will cut-in when the cabinet temperature reaches the set point+differential. In case of heating application, heater will cut-in when the temperature reaches the set point-differential.
r02	Minimum set point limitation The minimum allowable setpoint value can be configured here to avoid setting too low values by accident/mistake.
r03	Maximum set point limitation The maximum allowable setpoint value can be configured here to avoid setting too high values by accident/mistake.
r04	Display offset Correction value in display temperature. If the temperature at the products and the temperature received by the controller are not identical, an offset adjustment of the display temperature can be carried out under this menu code.
r05	Display temperature unit Set here if the controller is to show temperature values in °C or in °F. Switching from one to the other will cause all temperature settings to be automatically updated to respective unit.
r09	Calibration of Sair Offset for air temperature calibration. Compensation possibility due to long sensor cable.
r12	Main switch With this setting refrigeration can be started, stopped or a manual override of the outputs can be allowed. Stopped refrigeration will give a "OFF" signal on the display. <i>-1=service (manual control of outputs allowed)</i> <i>0=OFF</i> <i>1=ON</i>
r13	Night setback value The thermostat's reference will be the setpoint plus this value when the controller changes over to night operation. (Select a negative value if there is to be cold accumulation). Activation can take place via digital input.
r40	Thermostat reference displacement offset temperature The thermostat reference and the alarm values are shifted the following number of degrees when the reference displacement is activated. Activation can take place via digital input.

Menu code	Parameter description
r96	Pull-down duration Maximum duration of the pull-down mode.
r97	Pull-down limit temperature A safety feature; the lowest temperature allowed during pull-down.
A--	Alarm
A03	Delay for temperature alarm during normal conditions If the upper or the lower alarm limit values are exceeded, a timer function will commence. The alarm will not become active until the set time delay has been passed.
A12	Delay for temperature alarm during pull-down/start-up/defrost This time delay is used during start-up, during defrost, during pull-down. There will be change-over to the normal alarm time delay "A03" when the temperature falls within the alarm limits.
A13	High temperature alarm limit If the cabinet temperature stays above this limit for the time mentioned by the alarm delay, high temperature alarm is raised.
A14	Low temperature alarm limit If the cabinet temperature stays below this limit for the time mentioned by the alarm delay, low temperature alarm is raised.
A27	D11 delay If "D11" is configured as a door open alarm or as an external alarm, this delay is used to raise the respective alarm.
A28	D12 delay If "D12" is configured as a door open alarm or as an external alarm, this delay is used to raise the respective alarm.
A37	Condenser high alarm limit If the condenser temperature reaches above this limit, condenser alarm is raised immediately and no action is taken. The alarm is zeroset if temperature falls 5 K below the set temperature.
A54	Condenser high block limit If the condenser temperature continues to increase above the "A37" limit and reaches this temperature limit, condenser block alarm is raised and compressor is stopped. It is restricted to starting again until alarm is reset manually. Manual reset of condenser block alarm can be performed in two ways: - Power controller OFF and power ON controller again. - Switch controller OFF and ON again via main switch or front button.
A72	Voltage protection enable This parameter is to enable and disable the voltage protection feature, which protects compressor from adverse line voltage conditions.
A73	Minimum cut-in voltage When the compressor is due to start, the voltage of the power supply will be checked and the compressor will only be allowed to start if it is at least the value given in this parameter.
A74	Minimum cut-out voltage When the compressor is running, it will be switched OFF if the voltage goes below that given in this parameter.
A75	Maximum voltage When the compressor is running, it will be switched OFF if the voltage exceeds that given in this parameter. If the compressor is already stopped, it will remain switched OFF.
d--	Defrost
d01	Defrost method Here you set whether defrost is to be accomplished by electric, Hot gas or natural method. <i>no=none</i> <i>nAt=natural</i> <i>EL=electrical</i> <i>gAS=gas</i>
d02	Defrost stop temperature This parameter defines at what temperature the defrost cycle will stop. The temperature is given by the evaporator sensor or by the cabinet temperature sensor as defined in menu code "d10".
d03	Defrost interval Defines the time period between the start of two defrost cycles. In case of power failure elapsed time is stored in the memory and next defrost will happen after completing the defined time interval.

Menu code	Parameter description
d04	Maximum defrost time This parameter defines the defrost time when it is time based defrost. In case of temperature based defrost this is treated as safety time to stop the defrost if it is not terminated based on the temperature.
d05	Defrost delay at power up or DI signal This parameter decides the time offset when the defrost is triggered by digital inputs or during power up. This function is only relevant if you have several refrigeration appliances or groups where you want the defrost to be staggered in relation to one another.
d06	Drip-OFF time This parameter defines the time delay to start the compressor after defrost heater being switched OFF. This delay is generally provided to ensure all water droplets on the evaporator drips off before starting the refrigeration cycle.
d07	Fan delay after defrost Defines how long the delay is between the start of the compressor and the fan after defrost cycle.
d08	Fan start temperature after defrost This only applies if an evaporator temperature sensor is fitted. This parameter determines at what evaporator temperature the fan will start after a defrost cycle is complete. If the time set in "d07" occurs before the temperature set in "d08", the fan will start in line with "d07". If the temperature set in "d08" occurs first, then the fan will start in line with "d08".
d09	Fan during defrost This parameter is to define whether fan is to operate during defrost or not.
d10	Defrost stop sensor This parameter is to define which sensor has to be used to exit/terminate the defrost. <i>non=none, defrost is based on time</i> <i>Air=Sair sensor</i> <i>dEF=S5 (defrost) sensor</i>
d18	Compressor accumulated runtime to start defrost When the accumulated compressor runtime is equal to the value set in this Parameter, defrost will be triggered. If the compressor runtime is less than the set value during the define defrost interval "d03", defrost will be triggered based on the defrost interval "d03". This feature is disabled when this parameter is set to zero.
d19	Defrost on demand The controller will constantly monitor the "S5" temperature to estimate the ice buildup. In between two defrosts, if the "S5" temperature become lower than the value defined here controller will initiate the defrost on demand. This feature is disabled when this parameter is set to 20. This function can only be used in 1:1 systems.
d30	Defrost delay after pull down This parameter defines the time delay to start the defrost after pull down cycle. This has to ensure defrost doesn't happen immediately after pull down cycle.
F--	Fan control
F01	Fan at compressor cut-out This parameter define the fan operation during compressor OFF cycle. <i>FAo=fan always ON</i> <i>FFC=fan follow compressor</i> <i>FPL=fan Pulsating</i>
F04	Fan stop evaporating temperature This parameter defines the maximum evaporator temperature at which the Fan must switch OFF. If the defrost sensor registers a higher temperature than the one set here, the fans will be stopped to avoid the warm air circulation in the cabinet.
F07	Fan ON cycle This parameter is applicable only when the Fan at Compressor cut out "F01" is set to Fan Pulsating mode. The Fan pulsating ON time will be as per the time set in this parameter.
F08	Fan OFF cycle This parameter is applicable only when the Fan at Compressor cut out "F01" is set to Fan Pulsating mode. The Fan pulsating OFF time will be as per the time set in this parameter.
c--	Compressor
C01	Compressor minimum ON time This parameter determines the minimum number of minutes the compressor must run before a cut-out can take effect based on temperature. This is to avoid sudden switching ON and OFF of the compressor.
C02	Compressor minimum OFF time This parameter determines the minimum number of minutes the compressor must switched OFF before a cut-in can take effect based on temperature. This is to avoid sudden switching OFF and ON of the compressor.

Menu code	Parameter description
C04	Compressor OFF delay at door open This parameter sets the delay in minutes before the compressor stops when the door is opened. If set to zero, the function is disabled.
C70	Zero crossing selection This feature will increase the relay life time, reduce the contact welding and switching noise by switching ON at Zero crossing. Disable zero crossing when external relay is used.
o--	Others
o01	Delay of outputs at startup After start-up the controller functions can be delayed by the time delay defined here so that overloading of the electricity supply network is avoided.
o02	DI1 configuration Here you can configure the DI1 to one of the functions listed below. <i>oFF=not used</i> <i>Sdc=status display output</i> <i>doo=door alarm with resumption</i> (door function). When the input is open it signals that the door is open. Compressor/heater and fan are stopped after "C04 Compressor door open delay". After the time mentioned by "DI1 Delay" from the time door is opened, an alarm will be given and refrigeration will be resumed. <i>doA=door alarm without resumption</i> (door alarm). When the input is open it signals that the door is open. Compressor/heater and fan are stopped after "C04 Compressor door open delay" and will stay off until the door is closed. After the time mentioned by "DI1 Delay" from the time door is opened, an alarm will be given (and refrigeration will not be resumed). <i>SCH=main switch</i> . Regulation is carried out when the input is short-circuited, and regulation is stopped when the input is put in position OFF. <i>nig=day/night mode</i> . When the input is short-circuited, there will be regulation for night operation. <i>rFd=reference displacement</i> . Value in "r40" is added to the reference "r00" when the input is short-circuited <i>EAL=external alarm</i> . Alarm will be given when the input is short-circuited. <i>dEF=defrost</i> . Defrost is initiated when the input is short-circuited. Edge triggering is used. Defrost exit can take place by time, temperature or by manually pressing defrost push button on the front panel. <i>Pud=pull down</i> . Pull down is initiated when the input is short-circuited. Edge triggering is used. It will come out of pull down based on time and temperature defined under parameter "r96" and "r97" or can be stopped manually by pressing pull down push button on front panel. <i>Sc=condenser sensor</i>
o03	Serial address Data communication is possible through external TTL to RS485 gateway.
o05	Password If the settings in the controller are to be protected with an access code you can set a numerical value between 0 and 999. You can cancel the function by setting to 0.
o06	Sensor type selection This parameter is for defining type of temperature sensors connected to the controller. User can configure NTC 5 K, NTC 10 K, PTC and PT1000 sensors in this controller. All the mounted sensors (Sair, S5 and Sc) must be of same type.
o07	Cooling/heating This parameter is applicable only for single relay controller (ERC211) for selecting cooling or heating application.
o15	Display resolution This parameter defines the steps in which the temperature must be displayed by 0.1 or 0.5 or 1.
o23	Relay 1 counter The number of cycles for the "DO1" relay can be read in this menu. The read value is multiplied by 100 to obtain the number of cycles. On reaching 999x100 cycles the counts stops and is reset to 0.
o24	Relay 2 counter The number of cycles for the "DO2" relay can be read in this menu. The read value is multiplied by 100 to obtain the number of cycles. On reaching 999x100 cycles the counts stops and is reset to 0.
o25	Relay 3 counter The number of cycles for the DO3 relay can be read in this menu. The read value is multiplied by 100 to obtain the number of cycles. On reaching 999x100 cycles the counts stops and is reset to 0.

Menu code	Parameter description
o26	<p>Relay 4 counter</p> <p>The number of cycles for the DO4 relay can be read in this menu. The read value is multiplied by 100 to obtain the number of cycles. On reaching 999x100 cycles the counts stops and is reset to 0.</p>
o36	<p>DO4 configuration</p> <p>This parameter is to configure 4th relay as light or Alarm in case of 4 relay controller (ERC214). <i>Lig=light</i> <i>ALA=alarm</i></p>
o37	<p>DI2 configuration</p> <p>Here you can configure the DI1 to one of the functions listed below <i>oFF=not used</i> <i>Sdc=status display output</i> <i>doo=door alarm with resumption</i> (door function). When the input is open it signals that the door is open. Compressor/heater and fan are stopped after "C04 Compressor door open delay". After the time mentioned by "DI1 Delay" from the time door is opened, an alarm will be given and refrigeration will be resumed. <i>doA=door alarm without resumption</i> (door alarm). When the input is open it signals that the door is open. Compressor/heater and fan are stopped after "C04 Compressor door open delay" and will stay off until the door is closed. After the time mentioned by "DI1 Delay" from the time door is opened, an alarm will be given (and refrigeration will not be resumed). <i>SCH=main switch</i>. Regulation is carried out when the input is short-circuited, and regulation is stopped when the input is put in position OFF. <i>nig=day/ night mode</i>. When the input is short-circuited, there will be regulation for night operation. <i>rFd=reference displacement</i>. Value in "r40" is added to the reference "r00" when the input is short-circuited. <i>EAL=external alarm</i>. Alarm will be given when the input is short-circuited. <i>dEF=defrost</i>. Defrost is initiated when the input is short-circuited. Edge triggering is used. Defrost exit can take place by time, temperature or by manually pressing defrost push button on the front panel <i>Pud=pull down</i>. Pull down is initiated when the input is short-circuited. Edge triggering is used. It will come out of pull down based on time and temperature defined under parameter "r96" and "r97" or can be stopped manually by pressing pull down push button on front panel.</p>
o38	<p>Light control</p> <p>This parameter defines the way the light must be controlled. Below are the three light control modes available. <i>on=always on</i> <i>dAn=day/night</i> <i>doo=based on door action</i></p>
o61	<p>Predefined applications</p> <p>Predefined applications is to give the user an easy and fast way to configure the controller to a specific application based on storage temperature, defrost type and defrost method. Users can set appropriate application that meets their requirements under this menu (please refer predefined applications table under section 2.4 for more details). Predefined application is protected by main switch.</p>
o67	<p>Save settings as factory</p> <p>This parameter when set to YES. The current controller Parameter settings are stored as Factory default. WARNING: original factory settings are overwritten.</p>
o71	<p>DO2 configuration</p> <p>Here you can configure the second relay as defrost or alarm in case of three relay controller (ERC213). <i>dEF=defrost</i> <i>ALA=alarm</i></p>
o91	<p>Display at defrost</p> <p>You can set what is to be displayed during defrost here. <i>Air=actual air temperature</i> <i>FrE=freezed temperature(display the temperature just before starting defrost)</i> <i>-d="-d-" is displayed</i></p>

Menu code	Parameter description
P--	Polarity
P73	<p>D11 input polarity</p> <p>no (normally open)=associated functionality is activated when "D11" port is short circuit. The associated function is deactivated when "D11" port is open circuit.</p> <p>nc (normally closed)=associated functionality is activated when "D11" port is open circuit and deactivated when "D11" port is short circuit.</p>
P74	<p>D12 input polarity</p> <p>no (normally open)=associated functionality is activated when "D12" port is short circuit. The associated function is deactivated when "D12" port is open circuit.</p> <p>nc (normally closed)=associated functionality is activated when "D12" port is open circuit and deactivated when "D12" port is short circuit.</p>
P75	<p>Invert alarm relay</p> <p>Alarm relay operation can be inverted here</p> <p>0=normal</p> <p>1=invert relay action</p>
P76	<p>Key board lock enable</p> <p>YES=enable keyboard lock functionality after 5 minutes of no activity on the keypad.</p>

7| Parameter table

7.1| Parameter table - ERC 211

Parameter name - ERC 211	Code	Min	Max	Unit	App. 0 (Def.)	App. 1	App. 2	App. 3	App. 4	App. 5
Configuration	cFg									
Main switch <i>-1=service, 0=OFF, 1=ON</i>	r12	-1	1		1	1	1	1	1	1
Predefined applications <i>AP0, AP1, AP2, AP3, AP4, AP5</i>	o61	AP0	AP5		AP0	AP1	AP2	AP3	AP4	AP5
Sensor type selection <i>n5=NTC 5 K, n10=NTC 10 K, Ptc=PTC, Pt1=Pt1000</i>	o06	n5	Pt1		n10	n10	n10	n10	n10	n10
Reference/thermostat	r--									
Temperature setpoint	r00	-100.0	200.0	C/F	2.0	8.0	4.0	4.0	40.0	2.0
Differential	r01	0.1	20.0	K	2.0	2.0	2.0	2.0	2.0	2.0
Min set point limitation	r02	-100.0	200.0	C/F	-35.0	4.0	2.0	2.0	20.0	-35.0
Max set point limitation	r03	-100.0	200.0	C/F	50.0	20.0	6.0	6.0	60.0	50.0
Display offset (correction value in display temperature)	r04	-10.0	10.0	K	0.0	0.0	0.0	0.0	0.0	0.0
Display unit (°C/°F)	r05	-C	-F		-C	-C	-C	-C	-C	-C
Calibration of Sair (offset for air temperature calibration)	r09	-20.0	20.0	K	0.0	0.0	0.0	0.0	0.0	-
Main switch <i>-1=service, 0=OFF, 1=ON</i>	r12	-1	1		1	1	1	1	1	-
Night set back (offset temperature during night mode)	r13	-50.0	50.0	K	0.0	0.0	0.0	0.0	0.0	0.0
Thermostat reference displacement (offset temperature)	r40	-50.0	50.0	K	0.0	0.0	0.0	0.0	0.0	-
Pull-down duration	r96	0	960	min	0	-	0	0	-	-
Pull-down limit temperature	r97	-100.0	200.0	C/F	0.0	-	0.0	0.0	-	-
Alarm	A--									
Delay for temperature alarm during normal conditions	A03	0	240	min	30	45	45	45	30	30
Delay for temperature alarm during pull-down/start-up/defrost	A12	0	240	min	60	60	90	90	60	60
High temperature alarm limit (Cabinet/room)	A13	-100.0	200.0	C/F	8.0	16	10	10	80	8.0
Low temperature alarm limit	A14	-100.0	200.0	C/F	-30.0	0.0	0.0	0.0	10	-30.0
DI1 delay (time delay for selected DI1 function)	A27	0	240	min	30	30	30	30	30	30
Condenser high alarm limit	A37	0	200	C/F	80	80	80	80	-	-
Condenser high block limit	A54	0	200	C/F	85	85	85	85	-	-
Voltage protection enable	A72	no	yES		no	no	no	no	no	no
Minimum cut-in voltage	A73	0	270	V	0	0	0	0	0	0
Minimum cut-out voltage	A74	0	270	V	0	0	0	0	0	0

Note: hidden parameters are greyed out

Parameter name - ERC 211	Code	Min	Max	Unit	App. 0 (Def.)	App. 1	App. 2	App. 3	App. 4	App. 5
Maximum voltage	A75	0	270	V	270	270	270	270	270	270
Defrost	d--									
Defrost method <i>no=no defrost, nAt=natural</i>	d01	no	nAt		no	no	nAt	nAt	no	no
Defrost stop temperature	d02	0.0	50.0	C/F	6.0	-	-	8	-	6.0
Defrost interval	d03	0	240	hours	8	-	6	6	-	8
Max defrost time	d04	0	480	min	30	-	45	60	-	30
Defrost delay at power up (or DI signal)	d05	0	240.0	min	0	-	0	0	-	-
Drip delay	d06	0	60	min	0	-	0	0	-	-
Defrost stop sensor configuration <i>non=time</i> , <i>Air=Sair</i> (air temperature)	d10	non	Air		non	-	non	Air	-	non
Compressor accumulated runtime to start defrost <i>0=OFF</i>	d18	0	96	hours	0	-	0	0	-	-
Defrost delay after pull-down <i>0=OFF</i>	d30	0	960	min	0	-	0	0	-	-
Compressor	c--									
Compressor minimum ON time	C01	0	30	min	0	0	0	0	0	0.0
Compressor minimum OFF time	C02	0	30	min	2	2	2	2	2	2.0
Compressor OFF delay at door open	C04	0	15	min	0	0	0	0	0	1
Zero crossing selection	C70	no	yES		yES	yES	yES	yES	yES	yES
Others	o--									
Delay of outputs at startup	o01	0	600	min	5	5	5	5	5	5
DI1 configuration <i>oFF=not used</i> , <i>Sdc=status display output</i> , <i>doo=door alarm with resumption</i> , <i>doA=door alarm without resumption</i> , <i>SCH = main switch, nig=day/ night mode</i> , <i>rFd=reference displacement</i> , <i>EAL=external alarm, dEF=defrost</i> , <i>Pud=pull-down</i> , <i>Sc=condenser sensor</i>	o02	oFF	Sc		oFF	oFF	oFF	oFF	oFF	oFF
Serial address	o03	0	247		0	0	0	0	0	-
Password	o05	no	999		no	no	no	no	no	no
Sensor type selection <i>n5=NTC 5 K, n10=NTC 10 K</i> , <i>Ptc=PTC, Pt1=Pt1000</i>	o06	n5	Pt1		n10	n10	n10	n10	n10	-
Cooling/heating <i>rE=refrigeration (cooling)</i> <i>Ht=heating</i>	o07	rE	Ht		rE	rE	rE	rE	Ht	rE
Display resolution <i>0.1=steps of 0.1 °C</i> <i>0.5=steps of 0.5 °C</i> , <i>1.0=steps of 1.0 °C</i>	o15	0.1	1.0		0.1	0.1	0.1	0.1	0.1	0.1

Note: hidden parameters are greyed out

Parameter name - ERC 211	Code	Min	Max	Unit	App. 0 (Def.)	App. 1	App. 2	App. 3	App. 4	App. 5
Relay 1 counter (1 count=100 cycles of operation)	o23	0	999		0	0	0	0	0	-
Predefined applications	o61	AP0	AP5		AP0	AP1	AP2	AP3	AP4	-
Save settings as factory WARNING: the earlier factory settings are overwritten	o67	no	yES		no	no	no	no	no	-
Display at defrost <i>Air=actual air temperature, FrE=freezed temperature, -d="-d-" is displayed</i>	o91	Air	-d-		-d-	-	-d-	-d-	-	-d-
Polarity	P--									
DI1 input polarity <i>nc=normally closed, no=normally open</i>	P73	nc	no		no	no	no	no	no	no
Keyboard lock enable	P76	no	yES		no	no	no	no	no	-
Readouts	u--									
Controller status <i>S0=cooling ON/Heating ON, S2=wait for compressor ON time to elapse, S3=wait for compressor OFF time to elapse-restart time, S4=drip OFF delay after defrost, S10=cooling stop S11=cooling stopped by thermostat/heating OFF, S14=defrosting state, S15=fan delay state after defrost, S17=door open (DI input), S20=emergency cooling, S25>manual control of outputs, S30=continous cycle/Pull-down, S32=delay of outputs at power up</i>	u00	S0	S32		--					
Air temperature (Sair)	u01	-100.0	200.0	C/F	---					
Read the present regulation reference	u02	-100.0	200.0	C/F	---					
DI1 input	u10	oFF	oN		---					
Status of night operation	u13	oFF	oN		---					
Condenser temperature (Sc)	U09	-100.0	200.0	C/F	---					
Compressor relay status	u58	oFF	oN		---					
Firmware version readout	u80	000	999		---					

Note: hidden parameters are greyed out

7.2| Parameter table - ERC 213

Parameter Name - ERC 213	Code	Min	Max	Unit	App. 0 (Def.)	App. 1	App. 2	App. 3	App. 4	App. 5	App. 6
Configuration	cFg										
Main switch <i>-1=service, 0=OFF, 1=ON</i>	r12	-1	1		1	1	1	1	1	1	1
Predefined applications <i>AP0, AP1, AP2, AP3, AP4, AP5, AP6</i>	o61	AP0	AP6		AP0	AP1	AP2	AP3	AP4	AP5	AP6
Sensor type selection <i>n5=NTC 5 K, n10=NTC 10 K, Ptc=PTC, Pt1=Pt1000</i>	o06	n5	Pt1		n10	n10	n10	n10	n10	n10	n10
Reference/thermostat	r--										
Temperature setpoint	r00	-100.0	200.0	C/F	2.0	4.0	2.0	-24.0	2.0	-24.0	2.0
Differential	r01	0.1	20.0	K	2.0	2.0	2.0	2.0	2.0	2.0	2.0
Min set point limitation	r02	-100.0	200.0	C/F	-35.0	2.0	0.0	-26.0	0.0	-26.0	-35.0
Max set point limitation	r03	-100.0	200.0	C/F	50.0	6.0	4.0	-20.0	4.0	-20.0	50.0
Display offset (correction value in display temperature)	r04	-10.0	10.0	K	0.0	0.0	0.0	0.0	0.0	0.0	0.0
Display Unit (°C/°F)	r05	-C	-F		-C	-C	-C	-C	-C	-C	-C
Calibration of Sair (offset for air temperature calibration)	r09	-20.0	20.0	K	0.0	0.0	0.0	0.0	0.0	0.0	-
Main switch <i>-1=service, 0=OFF, 1=ON</i>	r12	-1	1		1	1	1	1	1	1	-
Night set back (offset temperature during night mode)	r13	-50.0	50.0	K	0.0	0.0	0.0	0.0	0.0	0.0	0.0
Thermostat reference displacement (offset temperature)	r40	-50.0	50.0	K	0.0	0.0	0.0	0.0	0.0	0.0	-
Pull-down duration	r96	0	960	min	0	0	0	0	0	0	-
Pull-down limit temperature	r97	-100.0	200.0	C/F	0.0	0.0	0.0	0.0	0.0	0.0	-
Alarm	A--										
Delay for temperature alarm during normal conditions	A03	0	240	min	30	45	30	30	30	30	30
Delay for temperature alarm during pull-down/start-up/ defrost	A12	0	240	min	60	90	60	60	60	60	60
High temperature alarm limit (Cabinet/Room)	A13	-100.0	200.0	C/F	8.0	10.0	8.0	-15.0	8.0	-15.0	8.0
Low temperature alarm limit	A14	-100.0	200.0	C/F	-30.0	0.0	-2.0	-30.0	-2.0	-30.0	-30.0
DI1 delay (time delay for selected DI1 function)	A27	0	240	min	30	30	30	30	30	30	30
DI2 delay (time delay for selected DI2 function)	A28	0	240	min	30	30	30	30	30	30	30
Condenser high alarm limit	A37	0	200	C/F	80	80	80	80	80	80	-
Condenser high block limit	A54	0	200	C/F	85	85	85	85	85	85	-
Voltage protection enable	A72	no	yES		no	no	no	no	no	no	no
Minimum cut-in voltage	A73	0	270	V	0	0	0	0	0	0	0
Minimum cut-out voltage	A74	0	270	V	0	0	0	0	0	0	0
Maximum voltage	A75	0	270	V	270	270	270	270	270	270	270

Note: hidden parameters are greyed out

Parameter Name - ERC 213	Code	Min	Max	Unit	App. 0 (Def.)	App. 1	App. 2	App. 3	App. 4	App. 5	App. 6
Defrost	d--										
Defrost method <i>no=no defrost, nAt=natural, EL=electrical, gAS=hot gas</i>	d01	no	gAS		EL	nAt	EL	EL	EL	EL	EL
Defrost stop temperature	d02	0.0	50.0	C/F	6.0	-	-	-	6.0	6.0	6.0
Defrost interval	d03	0	240	hours	8	6	8	12	8	12	8
Max defrost time	d04	0	480	min	30	45	15	15	30	30	30
Defrost delay at power up (or DI signal)	d05	0	240.0	min	0	0	0	0	0	0	-
Drip delay	d06	0	60	min	0	0	0	0	0	0	5
Fan delay after defrost	d07	0	60	min	0	0	0	0	0	0	5
Fan start temperature after defrost	d08	-50.0	0.0	C/F	-5.0	-	-	-	-5.0	-5.0	-
Fan during defrost	d09	oFF	on		on	on	on	on	on	on	on
Defrost stop sensor configuration <i>non=time, Air=Sair (air temperature), dEF=S5 (defrost sensor)</i>	d10	non	dEF		non	non	non	non	dEF	dEF	non
Compressor accumulated runtime to start defrost <i>0=OFF</i>	d18	0	96	hours	0	0	0	0	0	0	-
Defrost on demand <i>20.0=OFF</i>	d19	0.0	20.0	K	20.0	-	-	-	20.0	20.0	-
Defrost delay after pull-down <i>0=OFF</i>	d30	0	960	min	0	0	0	0	0	0	-
Fan control	F--										
Fan at compressor cutout <i>FFc=fan follow compressor, FAo=fan always ON, FPL=fan pulsating</i>	F01	FFc	FPL		FAo	FAo	FAo	FAo	FAo	FAo	FAo
Fan stop evaporator temperature <i>50.0=OFF</i>	F04	-50.0	50.0	C/F	50.0	-	-	-	50.0	50.0	-
Fan ON cycle	F07	0	15	min	2	2	2	2	2	2	2
Fan OFF cycle	F08	0	15.0	min	2	2	2	2	2	2	2
Compressor	c--										
Compressor minimum ON time	C01	0	30	min	0	0	0	0	0	0	0
Compressor minimum OFF time	C02	0	30	min	2	2	2	2	2	2	2
Compressor OFF delay at door open	C04	0	15	min	0	0	0	0	0	0	1
Zero crossing selection	C70	no	yES		yES	yES	yES	yES	yES	yES	yES

Note: hidden parameters are greyed out

Parameter Name - ERC 213	Code	Min	Max	Unit	App. 0 (Def.)	App. 1	App. 2	App. 3	App. 4	App. 5	App. 6
Others	o--										
Delay of outputs at startup	o01	0	600	min	5	5	5	5	5	5	5
DI1 configuration <i>oFF=not used, Sdc=status display output, doo=door alarm with resumption, doA=door alarm without resumption, SCH=main switch, nig=day/night mode, rFd=reference displacement, EAL=external alarm, dEF=defrost, Pud=pull-down, Sc=condenser sensor</i>	o02	oFF	Sc		oFF	oFF	oFF	oFF	oFF	oFF	oFF
Serial address	o03	0	247		0	0	0	0	0	0	-
Password	o05	no	999		no	no	no	no	no	no	no
Sensor type selection <i>n5=NTC 5 K, n10=NTC 10 K, Ptc=PTC, Pt1=Pt1000</i>	o06	n5	Pt1		n10	n10	n10	n10	n10	n10	-
Display resolution <i>0.1=steps of 0.1 °C 0.5=steps of 0.5 °C, 1.0=steps of 1.0 °C</i>	o15	0.1	1.0		0.1	0.1	0.1	0.1	0.1	0.1	0.1
Relay 1 counter (1 count=100 cycles of operation)	o23	0	999		0	0	0	0	0	0	-
Relay 2 counter (1 count=100 cycles of operation)	o24	0	999		0	0	0	0	0	0	-
Relay 3 counter (1 count=100 cycles of operation)	o25	0	999		0	0	0	0	0	0	-
DI2 configuration <i>oFF=not used, Sdc=status display output, doo=door alarm with resumption, doA=door alarm without resumption, SCH=main switch, nig=day/night mode, rFd=reference displacement, EAL=external alarm, dEF=defrost, Pud=pull-down</i>	o37	oFF	Pud		oFF	oFF	oFF	oFF	oFF	oFF	oFF
Predefined applications	o61	AP0	AP6		AP0	AP1	AP2	AP3	AP4	AP5	-
Save settings as factory WARNING: the earlier factory settings are overwritten	o67	no	yES		no	no	no	no	no	no	-
DO2 config <i>dEF=defrost; ALA=alarm</i>	o71	dEF	ALA		dEF	ALA	dEF	dEF	dEF	dEF	dEF
Display at defrost <i>Air=actual air temperature, FrE=freezed temperature, -d="d-" is displayed</i> Note: hidden parameters are greyed out	o91	Air	-d-		-d-	-d-	-d-	-d-	-d-	-d-	-d-

Parameter Name - ERC 213	Code	Min	Max	Unit	App. 0 (Def.)	App. 1	App. 2	App. 3	App. 4	App. 5	App. 6
Polarity	P--										
DI1 input polarity <i>nc=normally closed, no=normally open</i>	P73	nc	no		no	no	no	no	no	no	no
DI2 input polarity <i>nc=normally closed, no=normally open</i>	P74	nc	no		no	no	no	no	no	no	no
Invert alarm relay <i>0=normal, 1=invert relay action</i>	P75	0	1		0	0	-	-	-	-	-
Keyboard lock enable	P76	no	yES		no	no	no	no	no	no	-
Readouts	u--										
Controller Status <i>S0=cooling ON/Heating ON, S2=wait for compressor ON time to elapse, S3=wait for compressor OFF time to elapse-restart time, S4=drip OFF delay after defrost, S10=cooling stop S11=cooling stopped by thermostat/heating OFF, S14=defrosting state, S15=fan delay state after defrost, S17=door open (DI input), S20=emergency cooling, S25=manual control of outputs, S30=continous cycle/Pull-down, S32=delay of outputs at power up</i>	u00	S0	S32		--						
Air temperature (Sair)	u01	-100.0	200.0	C/F	---						
Read the present regulation reference	u02	-100.0	200.0	C/F	---						
Defrost temperature (S5)	u09	-100.0	200.0	C/F	---	-	-	-			
DI1 input	u10	oFF	on		---						
Status of night operation	u13	oFF	on		---						
DI2 input	u37	oFF	on		---						
Condenser temperature (Sc)	U09	-100.0	200.0	C/F	---						
Compressor relay status	u58	oFF	on		---						
Fan relay status	u59	oFF	on		---						
Defrost relay status	u60	oFF	on		---						
Light relay status	u63	oFF	on		---						
Firmware version readout	u80	000	999		---						

Note: hidden parameters are greyed out

7.3| Parameter table - ERC 214

Parameter name - ERC 214	Code	Min	Max	Unit	App. 0 (Def.)	App. 1	App. 2	App. 3	App. 4	App. 5	App. 6
Configuration	cFg										
Main switch <i>-1=service, 0=OFF, 1=ON</i>	r12	-1	1		1	1	1	1	1	1	1
Predefined applications <i>AP0, AP1, AP2, AP3, AP4, AP5, AP6</i>	o61	AP0	AP6		AP0	AP1	AP2	AP3	AP4	AP5	AP6
Sensor type selection <i>n5=NTC 5 K, n10=NTC 10 K, Ptc=PTC, Pt1=Pt1000</i>	o06	n5	Pt1		n10	n10	n10	n10	n10	n10	n10
DO4 configuration <i>Lig=light, ALA=alarm</i>	o36	Lig	ALA		Lig	Lig	Lig	Lig	Lig	Lig	Lig
Reference/thermostat	r--										
Temperature setpoint	r00	-100.0	200.0	C/F	2.0	4.0	2.0	-24.0	2.0	-24.0	2.0
Differential	r01	0.1	20.0	K	2.0	2.0	2.0	2.0	2.0	2.0	2.0
Min set point limitation	r02	-100.0	200.0	C/F	-35.0	2.0	0.0	-26.0	0.0	-26.0	-35.0
Max set point limitation	r03	-100.0	200.0	C/F	50.0	6.0	4.0	-20.0	4.0	-20.0	50.0
Display offset (correction value in display temperature)	r04	-10.0	10.0	K	0.0	0.0	0.0	0.0	0.0	0.0	0.0
Display Unit (°C/°F)	r05	-C	-F		-C	-C	-C	-C	-C	-C	-C
Calibration of Sair (offset for air temperature calibration)	r09	-20.0	20.0	K	0.0	0.0	0.0	0.0	0.0	0.0	-
Main switch <i>-1=service, 0=OFF, 1=ON</i>	r12	-1	1		1	1	1	1	1	1	-
Night set back (offset temperature during night mode)	r13	-50.0	50.0	K	0.0	0.0	0.0	0.0	0.0	0.0	0.0
Thermostat reference displacement (offset temperature)	r40	-50.0	50.0	K	0.0	0.0	0.0	0.0	0.0	0.0	-
Pull-down duration	r96	0	960	min	0	0	0	0	0	0	-
Pull-down limit temperature	r97	-100.0	200.0	C/F	0.0	0.0	0.0	0.0	0.0	0.0	-
Alarm	A--										
Delay for temperature alarm during normal conditions	A03	0	240	min	30	45	30	30	30	30	30
Delay for temperature alarm during pull-down/start-up/defrost	A12	0	240	min	60	90	60	60	60	60	60
High temperature alarm limit (Cabinet/Room)	A13	-100.0	200.0	C/F	8.0	10.0	8.0	-15.0	8.0	-15.0	8.0
Low temperature alarm limit	A14	-100.0	200.0	C/F	-30.0	0.0	-2.0	-30.0	-2.0	-30.0	-30.0
DI1 delay (time delay for selected DI1 function)	A27	0	240	min	30	30	30	30	30	30	30
DI2 delay (time delay for selected DI2 function)	A28	0	240	min	30	30	30	30	30	30	30
Condenser high alarm limit	A37	0	200	C/F	80	80	80	80	80	80	-
Condenser high block limit	A54	0	200	C/F	85	85	85	85	85	85	-
Voltage protection enable	A72	no	yES		no	no	no	no	no	no	no
Minimum cut-in voltage	A73	0	270	V	0	0	0	0	0	0	0
Minimum cut-out voltage	A74	0	270	V	0	0	0	0	0	0	0
Maximum voltage	A75	0	270	V	270	270	270	270	270	270	270

Note: hidden parameters are greyed out

Parameter name - ERC 214	Code	Min	Max	Unit	App. 0 (Def.)	App. 1	App. 2	App. 3	App. 4	App. 5	App. 6
Defrost	d--										
Defrost method <i>no=no defrost, nAt=natural, EL=electrical, gAS=hot gas</i>	d01	no	gAS		EL	nAt	EL	EL	EL	EL	EL
Defrost stop temperature	d02	0.0	50.0	C/F	6.0	-	-	-	6.0	6.0	6.0
Defrost interval	d03	0	240	hours	8	6	8	12	8	12	8
Max defrost time	d04	0	480	min	30	45	15	15	30	30	30
Defrost delay at power up (or DI signal)	d05	0	240.0	min	0	0	0	0	0	0	-
Drip delay	d06	0	60	min	0	0	0	0	0	0	5
Fan delay after defrost	d07	0	60	min	0	0	0	0	0	0	5
Fan start temperature after defrost	d08	-50.0	0.0	C/F	-5.0	-	-	-	-5.0	-5.0	-
Fan during defrost	d09	oFF	on		on	on	on	on	on	on	on
Defrost stop sensor configuration non=time, Air=Sair (air temperature), dEF=S5 (defrost sensor)	d10	non	dEF		non	non	non	non	dEF	dEF	non
Compressor accumulated runtime to start defrost 0=OFF	d18	0	96	hours	0	0	0	0	0	0	-
Defrost on demand 20.0=OFF	d19	0.0	20.0	K	20.0	-	-	-	20.0	20.0	-
Defrost delay after pull-down 0=OFF	d30	0	960	min	0	0	0	0	0	0	-
Fan control	F--										
Fan at compressor cutout <i>FFc=fan follow compressor, FAo=fan always ON, FPL=fan pulsating</i>	F01	FFc	FPL		FAo	FAo	FAo	FAo	FAo	FAo	FAo
Fan stop evaporator temperature 50.0=OFF	F04	-50.0	50.0	C/F	50.0	-	-	-	50.0	50.0	-
Fan ON cycle	F07	0	15	min	2	2	2	2	2	2	2
Fan OFF cycle	F08	0	15.0	min	2	2	2	2	2	2	2
Compressor	c--										
Compressor minimum ON time	C01	0	30	min	0	0	0	0	0	0	0
Compressor minimum OFF time	C02	0	30	min	2	2	2	2	2	2	2
Compressor OFF delay at door open	C04	0	15	min	0	0	0	0	0	0	1
Zero crossing selection	C70	no	yES		yES	yES	yES	yES	yES	yES	yES

Note: hidden parameters are greyed out

Parameter name - ERC 214	Code	Min	Max	Unit	App. 0 (Def.)	App. 1	App. 2	App. 3	App. 4	App. 5	App. 6
Others	o--										
Delay of outputs at startup	o01	0	600	min	5	5	5	5	5	5	5
DI1 configuration <i>oFF=not used, Sdc=status display output, doo=door alarm with resumption, doA=door alarm without resumption, SCH = main switch, nig=day/ night mode, rFd=reference displacement, EAL=external alarm, dEF=defrost, Pud=pull-down, Sc=condenser sensor</i>	o02	oFF	Sc		oFF	oFF	oFF	oFF	oFF	oFF	oFF
Serial address	o03	0	247		0	0	0	0	0	0	-
Password	o05	no	999		no	no	no	no	no	no	0
Sensor type selection <i>n5=NTC 5 K, n10=NTC 10 K, Ptc=PTC, Pt1=Pt1000</i>	o06	n5	Pt1		n10	n10	n10	n10	n10	n10	-
Display Resolution <i>0.1=steps of 0.1 °C 0.5=steps of 0.5 °C, 1.0=steps of 1.0 °C</i>	o15	0.1	1.0		0.1	0.1	0.1	0.1	0.1	0.1	0.1
Relay 1 counter (1 count=100 cycles of operation)	o23	0	999		0	0	0	0	0	0	-
Relay 2 counter (1 count=100 cycles of operation)	o24	0	999		0	0	0	0	0	0	-
Relay 3 counter (1 count=100 cycles of operation)	o25	0	999		0	0	0	0	0	0	-
Relay 4 counter (1 count=100 cycles of operation)	o26	0	999		0	0	0	0	0	0	-
DO4 configuration <i>ALA=alarm, Lig=light</i>	o36	ALA	Lig		Lig	Lig	Lig	Lig	Lig	Lig	-
DI2 configuration <i>oFF=not used, Sdc=status display output, doo=door alarm with resumption, doA=door alarm without resumption, SCH=main switch, nig=day/night mode, rFd=reference displacement, EAL=external alarm, dEF=defrost, Pud=pull-down</i>	o37	oFF	Pud		oFF	oFF	oFF	oFF	oFF	oFF	oFF
Light Control <i>on=always on, dAn=day/night, doo=based on door action</i>	o38	on	doo		on	on	on	on	on	on	on
Predefined applications	o61	AP0	AP6		AP0	AP1	AP2	AP3	AP4	AP5	-
Save settings as factory WARNING: the earlier factory settings are overwritten	o67	no	yES		no	no	no	no	no	no	-
Display at defrost <i>Air=actual air temperature, FrE=freezed temperature, -d="-d" is displayed</i>	o91	Air	-d-		-d-	-d-	-d-	-d-	-d-	-d-	-d-

Note: hidden parameters are greyed out

Parameter name - ERC 214	Code	Min	Max	Unit	App. 0 (Def.)	App. 1	App. 2	App. 3	App. 4	App. 5	App. 6
Polarity	P--										
DI1 input polarity <i>nc=normally closed, no=normally open</i>	P73	nc	no		no	no	no	no	no	no	no
DI2 input polarity <i>nc=normally closed, no=normally open</i>	P74	nc	no		no	no	no	no	no	no	no
Invert alarm relay <i>0=normal, 1=invert relay action</i>	P75	0	1		0	0	0	0	0	0	-
Keyboard lock enable	P76	no	yES		no	no	no	no	no	no	-
Readouts	u--										
Controller status <i>S0=cooling ON/Heating ON, S2=wait for compressor ON time to elapse, S3=wait for compressor OFF time to elapse-restart time, S4=drip OFF delay after defrost, S10=cooling stop S11=cooling stopped by thermostat/heating OFF, S14=defrosting state, S15=fan delay state after defrost, S17=door open (DI input), S20=emergency cooling, S25=manual control of outputs, S30=continous cycle/Pull-down, S32=delay of outputs at power up</i>	u00	S0	S32		--						
Air temperature (Sair)	u01	-100.0	200.0	C/F	---						
Read the present regulation reference	u02	-100.0	200.0	C/F	---						
Defrost temperature (S5)	u09	-100.0	200.0	C/F	---	-	-	-			
DI1 input	u10	oFF	on		---						
Status of night operation	u13	oFF	on		---						
DI2 input	u37	oFF	on		---						
Condenser temperature (Sc)	U09	-100.0	200.0	C/F	---						
Compressor relay status	u58	oFF	on		---						
Fan relay status	u59	oFF	on		---						
Defrost relay status	u60	oFF	on		---						
Alarm relay status	u62	oFF	on		---						
Light relay status	u63	oFF	on		---						
Firmware version readout	u80	000	999		---						

Note: hidden parameters are greyed out

7.4| Alarm Code

Alarm status	Alarm Code
Air temperature sensor (Sair) error	E29
Defrost sensor (S5) error	E27
Condenser sensor (Sc) error	E30
High temperature alarm	A01
Low temperature alarm	A02
High voltage alarm	A99
Low voltage alarm	AA1
High condenser temperature alarm	A61
Door alarm	A04
Standby alarm	A45
DI external alarm	A15

7.5| Troubleshooting

Problem	Probable cause	Remedy
Compressor does not start	Waiting for compressor delay timer	Check c-- → "C02"
	Defrost in progress	Check d-- → "d03"
		Check d-- → "d19"
	Line voltage to compressor too low or too high	Check A-- → "A72" Check A-- → "A73" Check A-- → "A75"
Defrost does not start	Controller in pull down mode	Check r-- → "r96"
Pull-down does not start	Pull-down max duration is 0	Check r-- → "r96"
	Pull-down limit temperature too high	Check r-- → "r97"
Wrong temperature displayed	Wrong type of sensor selected	Check cFg → "o06"

8| Ordering

Type	Description	Relay	Number	Code no.
ERC 211	RED LED, 115 V, Single/Multi Pack	1	1	080G3290
ERC 211	RED LED, 115 V, 1 sensor (NTC 10 kOhm at 25°C, L=1,5m), Single/Multi Pack	1	1	080G3262
ERC 213	RED LED, 115 V, Single/Multi Pack	3	1	080G3291
ERC 213	RED LED, 115 V, 2 sensors (NTC 10 kOhm at 25°C, L=1,5m), Single/Multi Pack	3	1	080G3264
ERC 214	RED LED, 115 V, Single/Multi Pack	4	1	080G3292
ERC 211	RED LED, 230 V, Single/Multi Pack	1	1	080G3293
ERC 211	RED LED, 230 V, 1 sensor (NTC 10 kOhm at 25°C, L=1,5m), Single/Multi Pack	1	1	080G3263
ERC 213	RED LED, 230 V, Single/Multi Pack	3	1	080G3294
ERC 213	RED LED, 230 V, 2 sensors (NTC 10 kOhm at 25°C, L=1,5m), Single/Multi Pack	3	1	080G3265
ERC 214	RED LED, 230 V, Single/Multi Pack	4	1	080G3295
ERC 211	RED LED, 230 V, Industrial Pack	1	30	080G3288
ERC 213	RED LED, 230 V, Industrial Pack	3	30	080G3289
ERC 214	RED LED, 230 V, Industrial Pack	4	30	080G3296
EKA 183B	Programming key for ERC 21X		1	080G9741

8.1| Sensors

Any of the below Danfoss sensors or equivalent.

Type	Sensor element	Sensor housing	Cable	Number	Code no.
EKS 211	NTC 5000 ohm / 25 °C (Beta =3980 at 25/100 °C)	Thermo plastic polyester 8x30	1.5 m	150	084B4403
		Thermo plastic polyester 8x30	3.5 m	75	084B4404
		Thermo plastic polyester 8x30	1.5 m	1	084N1220
		Thermo plastic polyester 8x30	3.5 m	1	084N1221
EKS 221	NTC 10000 ohm / 25 °C (Beta =3435 at 25/85 °C)	Thermo plastic rubber 6x5x15	3.5 m	150	084N3206
		Thermo plastic rubber 6x5x15	3.5 m	1	084N3210
		Thermo plastic rubber 6x5x15	8.5 m	50	084N3208
		Thermo plastic rubber 6x5x15	8.5 m	1	084N3209
		Stainless steel 6x20	1.5 m	150	084N3200
EKS 111	PTC 990 ohm / 25 °C	Stainless steel 6x30	1.5 m	1	084N1178
		Stainless steel 6x30	1.5 m	150	084N1161
		Stainless steel 6x30	3.5 m	1	084N1179
		Stainless steel 6x30	3.5 m	150	084N1163
		Stainless steel 6x30	6 m	1	084N1180
		Stainless steel 6x30	6 m	80	084N1173
		Stainless steel 6x30	8.5 m	60	084N1168
AKS 11	PT1000	Top part: PPO (Noryl) Bottom: stainless steel	3.5 m	1	084N0003
		Top part: PPO (Noryl) Bottom: stainless steel	5.5 m	1	084N0005
		Top part: PPO (Noryl) Bottom: stainless steel	8.5 m	1	084N0008
AKS 12	PT1000	Stainless steel 6x40	1.5 m	1	084N0036
		Stainless steel 6x40	1.5 m	30	084N0035
		Stainless steel 6x40	3.5 m	30	084N0039
		Stainless steel 6x40	5.5 m	30	084N0038

Note: all the mounted sensors must be of same type

Simple temperature and defrost management – **countless** functions and benefits

ERC 21X is a smart multipurpose refrigeration controller designed to fulfill today's requirements of commercial refrigeration applications.